

Loc-Line®

Das orange-blaue Original.







Wir haben dem System die grundlegende Form gegeben, und wir arbeiten weiter an seiner Vervollkommnung.

☞ Bei der einzigartigen Kugelverbindung von Loc-Line® kann sowohl die Position als auch die Länge einfach eingestellt und reguliert werden.



Die Idee mit der Kugelverbindung ist der Schlüssel zum Loc-Line®-System.

Die konische Form von Loc-Line® ermöglicht die volle Beweglichkeit in der Verbindung, ohne dass dabei der Durchlass eingeschränkt wird wie bei runden Elementformen.

☞ Der Durchlass-Querschnitt bleibt in jeder beliebigen Position konstant. Es entstehen keine Knicke oder Brüche wie bei Metallrohren.

☞ Im Gegensatz zu Metallschläuchen beschädigt Loc-Line® keine Schnittwerkzeuge.

☞ Loc-Line® leitet nicht, ist ideal für den Gebrauch als EDM-Kühlmittelschlauch.

☞ Loc-Line® hat keine Innenverstärkung, die den Durchfluss unterbrechen oder behindern könnte.

☞ Weder Kühlmitteldruck noch Maschinen-Vibrationen rütteln an der Positionstreu der Loc-Line®-Kühlmittelschläuche.



Beständigkeit der Loc-Line® orange/blau aus Azetal

	Ja	Azeton
Nein		Säuren
	Ja	Äthylalkohol
Nein		Ammoniumhydroxid (stark)
Nein		Basen (stark)
	Ja	Handelsübliche Abwaschmittel
	Ja	Benzin
	Ja	Fette
Nein		Hypochlorierte Ionenlösungen
	Ja	Lack-Lösungsmittel
	Ja	Öle
	Ja	Natriumhydroxid
Nein		Natriumhypochlorit

Loc-Line® wird aus einem erstklassigen Azetal-Copolymer hergestellt, das chemisch resistent ist gegenüber Erdölprodukten, Kühlmitteln und den gebräuchlichsten Chemikalien. Gewisse Teile sind auch in säureresistentem Polyester erhältlich.

Säurebeständige Loc-Line® gelb aus Polyester

Nein		Azeton
	Ja	Säuren (unter 65 °C)
Nein		Säuren (über 65 °C)
	Ja	Alkohole
	Ja	Aromatische Lösungsmittel
Nein		Chlorierte Kohlenwasserstoffe
Nein		Basen (stark)
Nein		Äthylazetat
	Ja	Benzin
	Ja	Fette
	Ja	Kohlenwasserstoffe
	Ja	Öle
	Ja	Salzlösungen
Nein		Wasser (über 65 °C)

Loc-Line® führt das flexible Originalschlauchkonzept weiter. Es gibt kein vergleichbares System mit einer so grossen Auswahl an Düsen, Verteilerelementen, Ventilen usw. Die neuen Düsen beweisen, dass die Flexibilität des Original-Konzepts erst begonnen hat.



Vier Schlauch-Durchmesser

- 1/4" = 6 mm
- 1/2" = 12 mm
- 3/4" = 19 mm
- 2 1/2" = 63 mm

Loc-Line® ist für Niederdruck ausgelegt. Der Maximaldruck für Loc-Line® ist abhängig von der Schlauchlänge, der Düsengrösse und dem Biegeradius. Die folgenden Angaben gelten als Richtwerte:











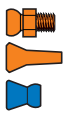





Dimension	Druck	Durchflussmenge
1/4" – 6 mm	2–4 bar	15 l/Min.
1/2" – 12 mm	1,4–2 bar	30 l/Min.
3/4" – 19 mm	0,7–2 bar	72 l/Min.













Temperaturangaben:

Schmelzpunkt: 165 °C

Max. Betriebstemperatur: 80 °C













Loc-Line® 1/4"-Modell









Typ	Artikel	CHF/Packung
	40413 1/4", 1/8" NPT Nippel, 3 Runddüsen, 20 Gelenkstücke, = 325 mm Länge	
	41400 Gelenkstücke, per Meter, = 70 Stück	
	41401 Gelenkstücke, 280 mm, = 2 Segmente à 10 Stück	
	49420 Gelenkstücke, 7,5 m, = 55 Segmente à 10 Stück	
	49421 Gelenkstücke, 15,2 m, = 1 Rolle à 1100 Stück	
	41402 4 Düsen, 1,6 mm 49422 50 Düsen	
	41403 4 Düsen, 3,2 mm 49423 50 Düsen	
	41404 4 Düsen, 6,4 mm 49424 50 Düsen	
	41407 2 Flachdüsen, 24 mm 49427 20 Flachdüsen	
	41405 4 Gewindenippel, 1/8" NPT 49425 50 Gewindenippel	
	41406 4 Gewindenippel, 1/4" NPT 49426 50 Gewindenippel	
	41411 4 Gewindemuffen, 1/8" NPT, Innengewinde 49431 20 Gewindemuffen	
	41408 2 Y-Abzweigstücke 49428 20 Y-Abzweigstücke	
	41409 4 Doppelmuffen, beidseitige Kupplung mit Gewindenippel oder Gelenkstücken 49429 20 Doppelmuffen	
	40655 4 Reduktionsmuffen, 1/4"-1/8", Innengewinde	
	40656 4 Doppelmuffen, 1/8", Innengewinde	
	40657 4 Doppelmuffen, 1/4", Innengewinde	
	41415 2 Winkelstücke 49435 20 Winkelstücke	
	41416 2 T-Stücke 49436 20 T-Stücke	

Typ	Artikel	CHF/Packung
	41470 4 Winkeldüsen, 1,6 mm 49439 20 Winkeldüsen	
	41471 4 Winkeldüsen, 3,2 mm 49440 20 Winkeldüsen	
	41472 4 Winkeldüsen, 6,4 mm 49441 20 Winkeldüsen	
	41473 2 Mehrlochwinkeldüsen, 22 mm 49442 20 Mehrlochwinkeldüsen	
	41474 Winkeldüsen-Kombi-Set, 1,6/3,2/6,4 mm und Mehrlochdüse	
	41475 Verlängerungs-/Briden-Set, 4 x Verlängerung 1/4", 4 x Bride mit Klemmschraube	
	41476 4 x Verlängerung 1/4", L = 95 mm 49445 20 Verlängerungen	
	41477 4 x Bride mit Klemmschraube 49446 20 Briden mit Klemmschrauben	
	41478 4 1/4" T-Düsen 41479 1/4" Ringdüsen, Satz, 15 1/4" T-Düsen, 1 1/4" Verschlusskappe	
	41480 4 1/4" Verschlusskappen	
	41481 2 Mehrloch-Schwenkdüsen, B = 40 mm, 16 x 1-mm-Loch 49449 20 Mehrloch-Schwenkdüsen, B = 40 mm, 16 x 1-mm-Loch	
	41482 2 Mehrloch-Schwenkdüsen, B = 40 mm, 16 x 1,5-mm-Loch 49450 20 Mehrloch-Schwenkdüsen, B = 40 mm, 16 x 1,5-mm-Loch	
	41488 2 Mehrloch-Schwenkdüsen, B = 63 mm, 20 x 1,9-mm-Loch 49455 20 Mehrloch-Schwenkdüsen, B = 63 mm, 20 x 1,9-mm-Loch	





Typ	Artikel	CHF/Packung
	41483 4 Flachdüsen 12 x 1 mm 49451 20 Flachdüsen	
	41484 4 Flachdüsen 12 x 1,5 mm 49452 20 Flachdüsen	
	41485 4 5-Lochdüsen Ø 1,5 mm 49453 20 5-Lochdüsen	
	41486 4 7-Lochdüsen Ø 1 mm 49454 20 7-Lochdüsen	
	41487 Flachdüsen-Kombi-Set, 4 Stück	
	21191 2 Rückschlagventile 29451 10 Rückschlagventile	
	21192 2 Kugelhähnen, einseitig, 1/4" NPT, Aussengewinde 29452 10 Kugelhähnen	
	21193 2 Kugelhähnen, einseitig, 1/4" NPT, Innengewinde 29453 10 Kugelhähnen	
	21194 2 Kugelhähnen, Ein- und Ausgang, System Loc-Line 29454 10 Kugelhähnen	
	21195 2 Dreifachhalter	
	21199 3 T-Stücke, 1 Winkelstück, 1 Dreifachhalter mit Schrauben	
	21198 5 Kugelhähnen, 3 T-Stücke, 1 Winkelstück, 1 Dreifachhalter mit Schrauben	
	78001 Montagezange, 1/4" 78003 Montagezangen-Set, 1/4" und 1/2"	











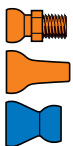



































Typ	Artikel	CHF/Packung
	40300 Magnetfuss mit Kugelhahn, Ausgang vertikal, Anschluss 1/4"	
	40301 Magnetfuss mit Kugelhahn, Ausgang horizontal, Anschluss 1/4"	
	40303 Magnetfuss mit 3 Kugelhähnen, Ausgänge vertikal, Anschlüsse 1/4"	
	40304 Magnetfuss mit 4 Kugelhähnen, Ausgänge vertikal, Anschlüsse 1/4"	
	40310 Metallkugelhahn separat, beidseitig, 1/4" Innengewinde	
	40305 Magnetfuss rund, Ø 54 mm, blau eloxiert, 1 Schlauch- anschluss, 4 Ausgänge mit 1/4" Innengewinde, 2 Verschlussstopfen 1/4"	
	40306 Magnetfuss 40305 mit zusätzlich 2 Loc-Line- Schläuchen, L = 325 mm, inkl. Rund- und Flachdüsen, 2 Kugelhähnen	
	40460 1 Kugelhahn, 1/4" NPT, 20 Gelenkstücke, 3 Rund- düsen, Ø 1,6/3,2/6,4 mm, 1 Flachdüse, 24 mm	

Neu

-  **41489** 2 Flachdüsen 25 mm gerader Strahl, ideal beim Schleifen und bei EDM-Anwendungen
- 49456** 20 Flachdüsen 25 mm



Flachdüsen und Düsen-Sortimente auf der Rückseite dieses Prospektes.





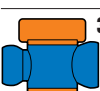

Loc-Line® 1/2"-Modell

Typ	Artikel	CHF/Packung	Typ	Artikel	CHF/Packung
	50813	3/8", 1/2" NPT Nippel, 3 Runddüsen, 12 Gelenkstücke, = 325 mm Länge		51824	2 Winkelstücke
	51800	Gelenkstücke, per Meter, = 46 Stück		59874	20 Winkelstücke
	51801	Gelenkstücke, 260 mm = 2 Segmente à 6 Stück		51825	2 T-Stücke
	59860	Gelenkstücke, 7,5 m, = 59 Segmente à 6 Stück		59875	20 T-Stücke
	59861	Gelenkstücke, 15,2 m, = 1 Rolle à 708 Stück		51828	4 Winkeldüsen, 6,4 mm
	51802	4 Düsen, 9,5 mm		59878	20 Winkeldüsen
	59862	50 Düsen		51829	4 Winkeldüsen, 9,5 mm
	51803	4 Düsen, 12,5 mm		59879	20 Winkeldüsen
	59863	50 Düsen		51830	4 Winkeldüsen, 12,5 mm
	51806	4 Düsen, 6,4 mm		59880	20 Winkeldüsen
	59866	50 Düsen		51831	2 Mehrlochwinkeldüsen, 47 mm
	51807	2 Flachdüsen, 30 mm		59881	20 Mehrlochwinkeldüsen
	59867	20 Flachdüsen		51832	Winkeldüsen-Kombi-Set, 6,4/9,5/12,5 mm und Mehrlöchdüse
	51809	2 Flachdüsen, 60 mm		51833	4 x Verlängerung, 1/2", L = 95 mm
	59871	20 Flachdüsen		59883	20 Verlängerungen
	51804	4 Gewindenippel, 3/8" NPT		51834	4 x Bride mit Klemmschraube
	59864	50 Gewindenippel		59884	20 Briden mit Klemmschrauben
	51805	4 Gewindenippel, 1/2" NPT		51835	Verlängerungs-/Briden-Set, 4 x Verlängerung, 1/2", 4 x Bride mit Klemmschraube
	59865	50 Gewindenippel			
	51808	2 Y-Abzweigstücke			
	59868	20 Y-Abzweigstücke			
	51822	2 Y-Abzweigreduktionen, 12/6 mm			
	59870	20 Y-Abzweigreduktionen			
	51821	2 Reduktionen, 12/6 mm			
	59869	20 Reduktionen			
	51811	4 Doppelmuffen, beidseitige Kupplung mit Gewindenippel oder Gelenkstücken			
	59872	20 Doppelmuffen			
	50660	4 Doppelmuffen, 3/8", Innengewinde			
	50661	4 Doppelmuffen, 1/2", Innengewinde			
	50658	4 Reduktionsmuffen, 3/8"-1/4", Innengewinde			
	50659	4 Reduktionsmuffen, 1/2"-1/4", Innengewinde			

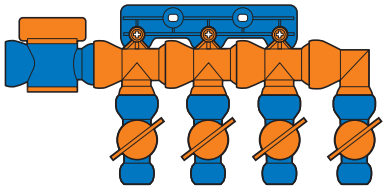



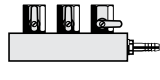



Typ	Artikel	CHF/Packung
	51836 4 1/2" T-Düsen 51837 1/2" Ringdüsen, Satz, 15 1/2" T-Düsen, 1 1/2" Verschlusskappe	
		
	51838 4 1/2" Verschlusskappen	
	51840 4 Flachdüsen 18x2 mm 59890 20 Flachdüsen	
	51841 4 Flachdüsen 18x3,2 mm 59891 20 Flachdüsen	
	51842 4 5-Lochdüsen Ø 3,2 mm 59892 20 5-Lochdüsen	
	51843 4 7-Lochdüsen Ø 2 mm 59893 20 7-Lochdüsen	
	51844 Flachdüsen-Kombi-Set, 4 Stück	
	51845 2 Mehrloch-Schwenkdüsen, B = 63 mm, 20 x 1,9-mm-Loch 59895 20 Mehrloch-Schwenkdüsen, B = 63 mm, 20 x 1,9-mm-Loch	
	32091 2 Rückschlagventile 39851 10 Rückschlagventile	
	32092 2 Kugelhähnen, einseitig, 1/2" NPT, Aussengewinde 39852 10 Kugelhähnen	
	32093 2 Kugelhähnen, einseitig, 1/2" NPT, Innengewinde 39853 10 Kugelhähnen	
	32094 2 Kugelhähnen, Ein- und Ausgang, System Loc-Line 39854 10 Kugelhähnen	
	32095 2 Dreifachhalter	
	32099 3 T-Stücke, 1 Winkelstück, 1 Dreifachhalter mit Schrauben	











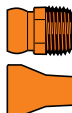

Typ	Artikel	CHF/Packung
	32098 5 Kugelhähnen, 3 T-Stücke, 1 Winkelstück, 1 Dreifachhalter mit Schrauben	
	78002 Montagezange, 1/2" 78003 Montagezangen-Set, 1/4" und 1/2"	
	50300 Magnetfuss mit Kugelhahn, Ausgang vertikal, Anschluss 3/8"	
	50301 Magnetfuss mit Kugelhahn, Ausgang horizontal, Anschluss 3/8"	
	50303 Magnetfuss mit 3 Kugelhähnen, Ausgänge vertikal, Anschlüsse 3/8"	
	50304 Magnetfuss mit 4 Kugelhähnen, Ausgänge vertikal, Anschlüsse 3/8"	
	50310 Metallkugelhahn separat, beidseitig, 3/8" Innengewinde	

Neu

	51847 2 Flachdüsen 32 mm gerader Strahl, ideal beim Schleifen und bei EDM-Anwendungen
	59897 20 Flachdüsen 32 mm
	51848 2 Flachdüsen 41 mm gerader Strahl, ideal beim Schleifen und bei EDM-Anwendungen
	59898 20 Flachdüsen 41 mm

**Flachdüsen und Düsen-Sortimente auf
der Rückseite dieses Prospektes.**









Loc-Line® 3/4"- Modell

Typ	Artikel	CHF/Packung
	60513 3/4" NPT Nippel, 2 Runddüsen, 12 Gelenkstücke, = 350 mm Länge	
		
	61500 Gelenkstücke, per Meter, = 42 Stück	
	61501 Gelenkstücke, 290 mm, = 2 Segmente à 6 Stück	
	69540 Gelenkstücke, 7,6 m, = 52 Segmente à 6 Stück	
	69541 Gelenkstücke, 15,2 m, = 1 Rolle à 638 Stück	
	61502 4 Düsen, 19 mm	
	69542 50 Düsen	
	61503 4 Düsen, 16 mm	
	69543 50 Düsen	
	61507 2 Flachdüsen, 75 mm	
	69547 20 Flachdüsen	



Typ	Artikel	CHF/Packung
	61505 4 Gewindenippel, 3/4" NPT	
	69545 50 Gewindenippel	
	61508 2 Reduktionen, 19/12 mm	
	69548 20 Reduktionen	
	61511 2 Y-Abzweigstücke	
	69551 20 Y-Abzweigstücke	
	61512 2 Y-Abzweigreduktionen, 19/12 mm	
	69552 20 Y-Abzweigreduktionen	
	61514 4 Doppelmuffen, beidseitige Kupplung mit Gewindenippel oder Gelenkstücken	
	69554 20 Doppelmuffen	
	78004 Montagezange, 3/4"	

Neu





Typ	Artikel	CHF/Packung
	61515 2 Winkelstücke	
	69555 20 Winkelstücke	
	61516 2 Kugelhahnen, einseitig, 3/4" NPT, Aussengewinde	
	69556 10 Kugelhahnen	
	61517 2 Kugelhahnen, einseitig, 3/4" NPT, Innengewinde	
	69557 10 Kugelhahnen	
	61518 2 Kugelhahnen, Ein- und Ausgang, System Loc-Line	
	69558 10 Kugelhahnen	

Loc-Line® Quick-Set-Shield

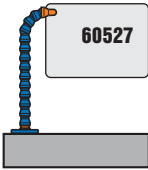
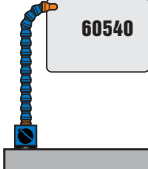
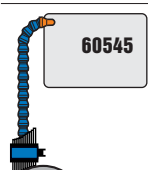

Einfache Montage: Magnetfuss positionieren, Sichtschutz in die richtige Lage drücken, fertig!

Polycarbonat-Sichtschutzschild 360° dreh- und leicht auswechselbar.

Typ	Artikel	CHF/Packung
	60527	Quick-Set-Shield, 216 x 300 mm, mit Permanent-Topfmagnetfuss und Loc-Line-Arm 350 mm
	60540	Quick-Set-Shield, 216 x 300 mm, mit schaltbarem Magnetfuss und Loc-Line-Arm 350 mm
	60545	Quick-Set-Shield, 216 x 300 mm, mit MAGNAFLEX Magnetfuss und Loc-Line-Arm 350 mm. Er klebt auch dort, wo normale Magnetfüsse wegen mangelnder Auflagefläche nicht halten!
	60528	Ersatz-Sichtschutzschild, 150 x 200 mm
	60529	Ersatz-Sichtschutzschild, 190 x 250 mm
	60530	Ersatz-Sichtschutzschild, 216 x 300 mm
	60531	2 Montagewinkel zu Quick-Set-Shield
	60532	Magnetfuss, Ø 70 mm mit Fussstück
	60533	2 Fussstücke









Verlangen Sie unsere Massblätter!

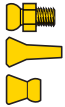





Loc-Line® Gelb 1/4"- Modell

Säurebeständig

Loc-Line Gelb hat einen in jeder Lage konstanten Durchlass-Querschnitt. Durchflussmenge ~ 15 l/min.

Typ	Artikel	CHF/Packung
	45463 1/4", 1/8" NPT Nippel, 3 Runddüsen, 20 Gelenkstücke, = 325 mm Länge	
	45400 Gelenkstücke, per Meter, = 70 Stück	
	45401 Gelenkstücke, 280 mm, = 2 Segmente à 10 Stück	
	46421 Gelenkstücke, 15,2 m, = 1 Rolle à 1100 Stück	
	45402 4 Düsen, 1,6 mm	
	46422 50 Düsen	
	45403 4 Düsen, 3,2 mm	
	46423 50 Düsen	
	45404 4 Düsen, 6,4 mm	
	46424 50 Düsen	
	45407 2 Flachdüsen, 24 mm	
	46427 20 Flachdüsen	
	45405 4 Gewindenippel, 1/8" NPT	
	46425 50 Gewindenippel	
	45406 4 Gewindenippel, 1/4" NPT	
	46426 50 Gewindenippel	
	45408 2 Y-Abzweigstücke	
	46428 20 Y-Abzweigstücke	

Typ	Artikel	CHF/Packung
	45409 4 Doppelmuffen	
	46429 20 Doppelmuffen	
	45411 4 Gewindemuffen, 1/8" NPT, Innengewinde	
	46431 20 Gewindemuffen	
	45415 2 Winkelstücke	
	46435 20 Winkelstücke	
	45416 2 T-Stücke	
	46436 20 T-Stücke	
	78001 Montagezange, 1/4"	
	78003 Montagezangen-Set, 1/4" und 1/2"	

Neu







	45481 2 Mehrloch-Schwenkdüsen, B = 40 mm, 16 x 1-mm-Loch	
	46449 20 Mehrloch-Schwenkdüsen, B = 40 mm, 16 x 1-mm-Loch	
	45482 2 Mehrloch-Schwenkdüsen, B = 40 mm, 16 x 1,5-mm-Loch	
	46450 20 Mehrloch-Schwenkdüsen, B = 40 mm, 16 x 1,5-mm-Loch	









Loc-Line® Gelb 1/2"- Modell

Säurebeständig









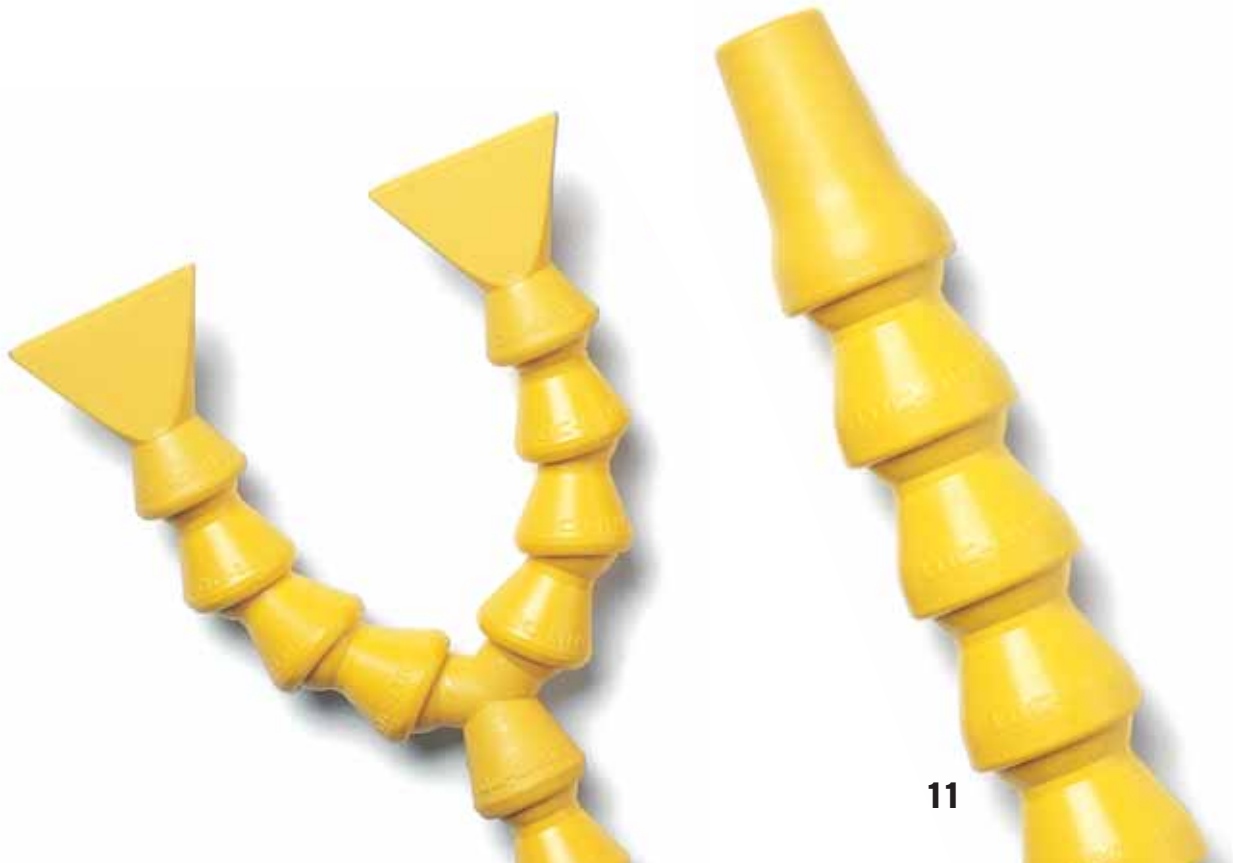



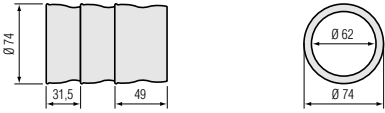
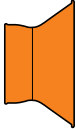

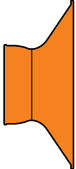
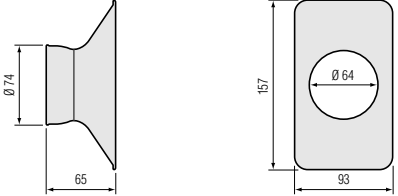
Loc-Line Gelb hat einen in jeder Lage konstanten Durchlass-Querschnitt. Durchflussmenge ~ 30 l/min.

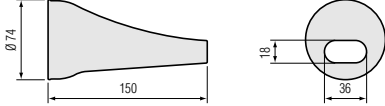
Typ	Artikel	CHF/Packung
	56863 3/8", 1/2" NPT Nippel, 3 Runddüsen, 12 Gelenkstücke, = 325 mm Länge	
	56800 Gelenkstücke, per Meter, = 46 Stück	
	56801 Gelenkstücke, 260 mm, = 2 Segmente à 6 Stück	
	57861 Gelenkstücke, 15,2 m, = 1 Rolle à 708 Stück	
	56802 4 Düsen, 9,5 mm	
	57862 50 Düsen	
	56803 4 Düsen, 12,5 mm	
	57863 50 Düsen	
	56806 4 Düsen, 6,4 mm	
	57866 50 Düsen	
	56807 2 Flachdüsen, 30 mm	
	57867 20 Flachdüsen	

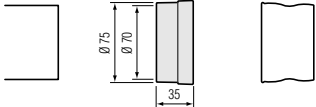
Typ	Artikel	CHF/Packung
	56804 4 Gewindenippel, 3/8" NPT	
	57864 50 Gewindenippel	
	56805 4 Gewindenippel, 1/2" NPT	
	57865 50 Gewindenippel	
	56808 2 Y-Abzweigstücke	
	57868 20 Y-Abzweigstücke	
	56822 2 Y-Abzweigreduktionen, 12/6 mm	
	57870 20 Y-Abzweigreduktionen	
	56821 2 Reduktionen, 12/6 mm	
	57869 20 Reduktionen	
	56824 2 Winkelstücke	
	57874 20 Winkelstücke	
	56825 2 T-Stücke	
	57875 20 T-Stücke	
	78002 Montagezange, 1/2"	
	78003 Montagezangen-Set, 1/4" und 1/2"	

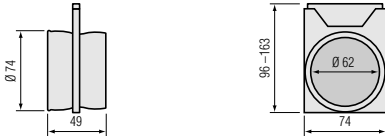

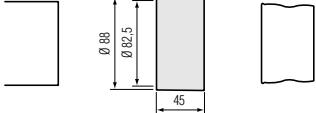
Loc-Line® 2 1/2" Absaug Schlauch

	Typ	Artikel	CHF/Packung	Vermassung	Angaben in mm
	81201	9 Gelenkstücke Ø 62 mm	= 301 mm		
	81202	18 Gelenkstücke Ø 62 mm	= 584 mm		
	89220	180 Gelenkstücke Ø 62 mm	= 5,68 m		
	81203	1 Runddüse Ø 119 mm			
	89223	10 Runddüsen Ø 119 mm			
	81204	1 Rechteckdüse	157 x 93 mm		
	89224	10 Rechteckdüsen	157 x 93 mm		
	81205	1 Ovaldüse	150 mm		
	81207	1 PVC Aussenadapter	Ø 75 mm		
	89227	10 PVC Aussenadapter	Ø 75 mm		
	81208	1 Schiebeventil	Ø 62 mm		
	89228	10 Schiebeventile	Ø 62 mm		
	81206	1 PVC Innenadapter	Ø 82,5 mm		
	89226	10 PVC Innenadapter	Ø 82,5 mm		
	82881	2 x 210 mm Adapter,	stufenlos verstellbar		
					

Der neue Loc-Line Absaug Schlauch dient als flexible Ergänzung zu einer bereits existierenden Absaugung von Rauch, Staub, Dampf, Gasen, Schmiernebel etc. Er kann leicht in die gewünschte Position gebogen und an PVC- oder Metallrohre angeschlossen werden.

- Von Hand kombinier- und einstellbar
- Biegeradius min. 150 mm
- Einfache Positionierung
- Sehr stabil
- Hergestellt aus Azetal-Copolymer, beständig gegen die meisten Chemikalien



	Typ	Artikel	CHF/Packung
	81301	9 Gelenkstücke Ø 62 mm = 301 mm	
	81302	18 Gelenkstücke Ø 62 mm = 584 mm	
	89320	180 Gelenkstücke Ø 62 mm = 5,68 m	
	81303	1 Runddüse Ø 119 mm	
	89323	10 Runddüsen Ø 119 mm	
	81304	1 Rechteckdüse 157 x 93 mm	
	89324	10 Rechteckdüsen 157 x 93 mm	
	81305	1 Ovaldüse 150 mm	
	89325	10 Ovaldüsen 150 mm	
	81307	1 PVC Aussenadapter Ø 75 mm	
	89327	10 PVC Aussenadapter Ø 75 mm	
	81308	1 Schiebeventil Ø 62 mm	
	89328	10 Schiebeventile Ø 62 mm	

Anwendungsgebiete

- Löten / Schweißen
- Nassschleifen
- Schmiernebel
- Lösungsmitteldämpfe
- Labor, Gase / Rauch (keine Säuren)
- Holzbearbeitung usw.

Zur Beachtung

Max. Betriebstemperatur: 80°C
Schmelzpunkt: 165°C

ANTI-STATIC

alle Teile anthrazit



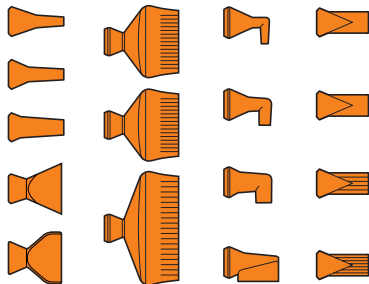

Loc-Line® 1/4"-Modell

Neu			
Typ	Artikel	CHF/Packung	
	41489	2 Flachdüsen 25 mm gerader Strahl, ideal beim Schleifen und bei EDM-Anwendungen	
	49456	20 Flachdüsen 25 mm	
<hr/>			
	41490	1/4" Rama Düsen-Sortiment, 16 verschiedene Düsen	



Loc-Line® 1/2"-Modell

Neu			
Typ	Artikel	CHF/Packung	
	51847	2 Flachdüsen 32 mm gerader Strahl, ideal beim Schleifen und bei EDM-Anwendungen	
	59897	20 Flachdüsen 32 mm	
	51848	2 Flachdüsen 41 mm gerader Strahl, ideal beim Schleifen und bei EDM-Anwendungen	
	59898	20 Flachdüsen 41 mm	
<hr/>			
	51849	1/2" Rama Düsen-Sortiment, 16 verschiedene Düsen	

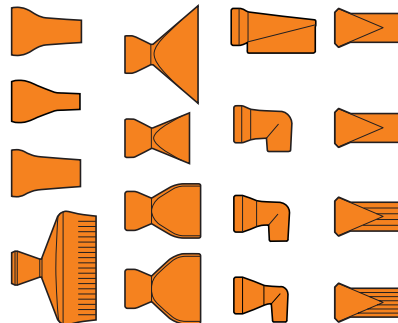

Alle Preise exkl. MWST

2004-11



Jakob AG
Qualitäts-Werkzeuge
Postfach 458
CH-8630 Rüti
Tel. ++41 55 240 27 79
Fax ++41 55 240 66 30
www.jakob-ag.ch
E-Mail: all@jakob-ag.ch